

Linear Thermal Transmittance (Ψ) and Temperature Factor (f)

Certificate No:	C4TM – 001522 vs. 0	Issued:	Saturday 27 April 2013
------------------------	----------------------------	----------------	-------------------------------

Issued to: *Jean-Marc Bouvier*
Nudura

NUDURA Corporation
International Sales & Field Support

Tel: Mob +44 (0) 7766 118711
Email: jmb@nudura.com
www.nudura.com

General Construction Specification: (see detail below for full construction)	Main/Load Bearing::	152mm (nominal) Dense Concrete Core, $\lambda \leq 2.00$
	Insulation:	2x 67mm layers of EPS + exterior extra 25mm, $\lambda = 0.036$
	Cavity:	15mm Cavity behind Brick if present
	Cladding:	9mm of Render OR 102mm Brick OR other Cladding
Description:	ICF Wall, Cill_EPS, EPS reveal closure	
Reference:	E3	Cill, EPS Closure + 152mm extra EPS

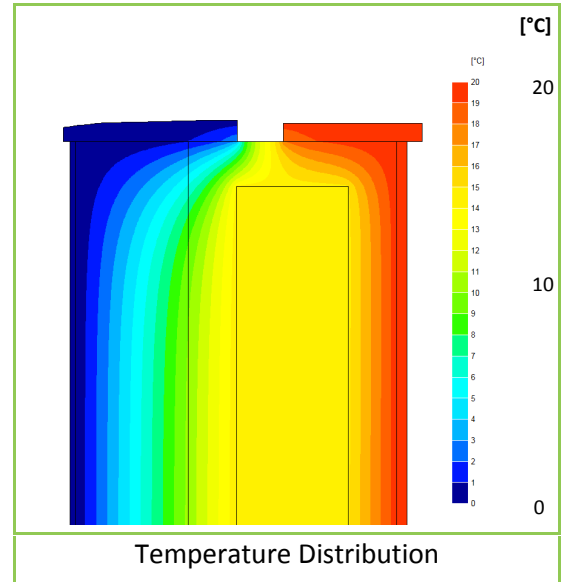
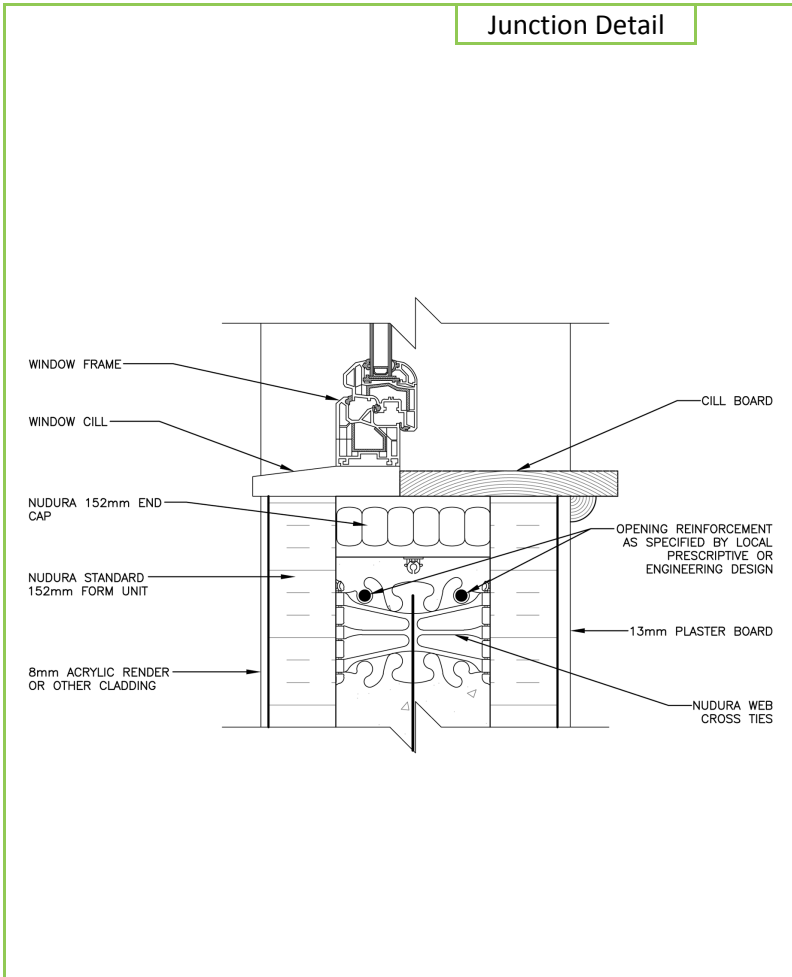

Linear Thermal Transmittance W/m.K	
$\Psi =$	0.022

Temperature Factor³ for Humidity and Mould	
$f =$	0.968

Calculation Prepared By: **Matthew Wright MA Physics (Oxon) PGCE**

Notes: Calculation based upon internal heat loss areas, applicable in UK Building Regulations and SAP calculations.

- Ψ and f are only valid for the detail drawn and described above.
- The Ψ and f quoted are considered valid for U-value(s) **Wall ≤ 0.12 W/m².K**, (allowance of +/- 20%, following the present guidance from B. Anderson, BRE, correspondence dated 24/02/2012, for the UK market). The use of different claddings may affect the U-value slightly, but will have no material impact on the calculated values used here, in this case.
- In dwellings, UK regulations stipulate that a temperature factor f that is >0.75 would avoid the risk of mould growth. For other nations, jurisdictions and climates, please consult the local building regulations that apply for avoiding mould and condensation. (For example, typical requirements may be: Netherlands: 0.65; Switzerland: 0.75; Belgium: 0.7; Germany: 0.7; Finland: 0.87. French, German and other standards often do not indicate a single number for acceptable risk, but are dependent on circumstances.)
- Calculations have been performed in accordance with:
 - EN ISO 10211_2007 (British Standards)
 - IP 1/06 & BR497 (BRE Press)
 and with reference to the following publications:
EN ISO 6946 (British Standards)
BR443 (BRE Press)